

# ATTENZIONE : PER QUESTA OPERAZIONE , DEVI DISATTIVARE L'ALIMENTAZIONE.

cod. **GMA200**

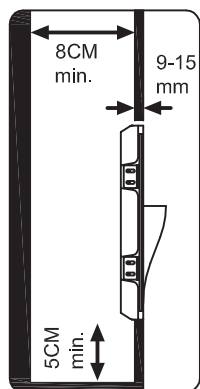

**GMA200**

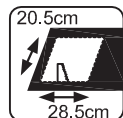

1

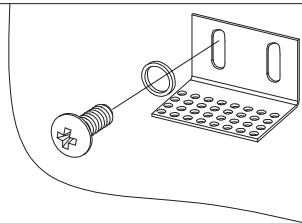

9~15mm

**Staffa perforata regolabile**

2

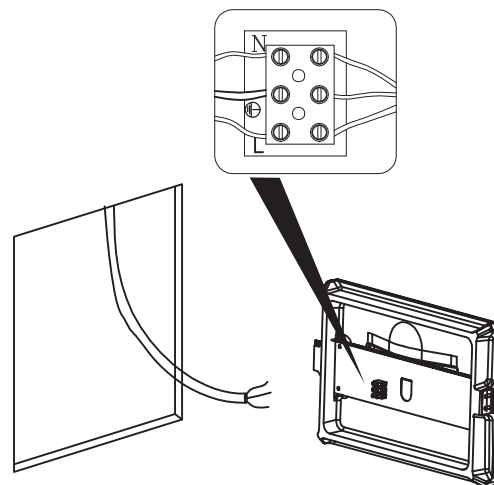

3

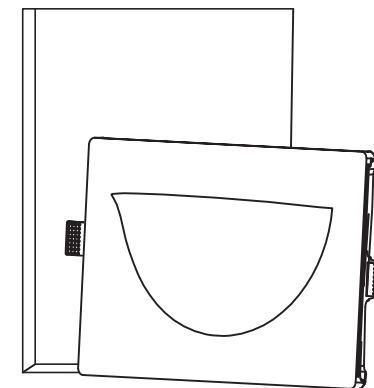

4

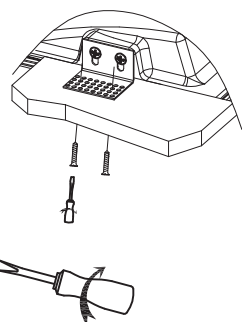
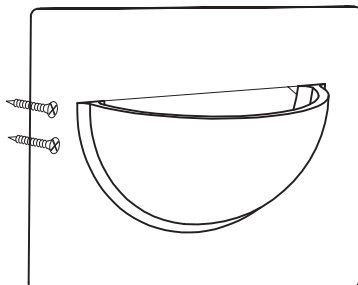

5

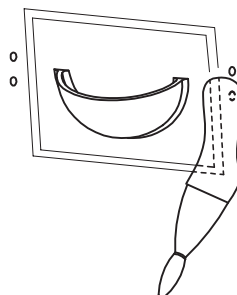
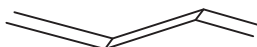

6

